

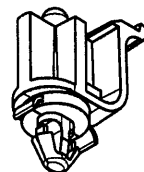

REVISIONS			
REV	DESCRIPTION	DATE	BY

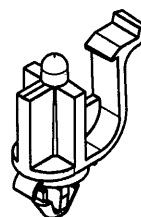
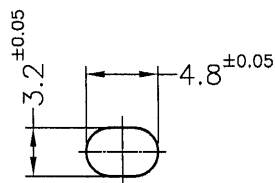
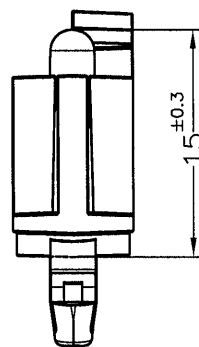
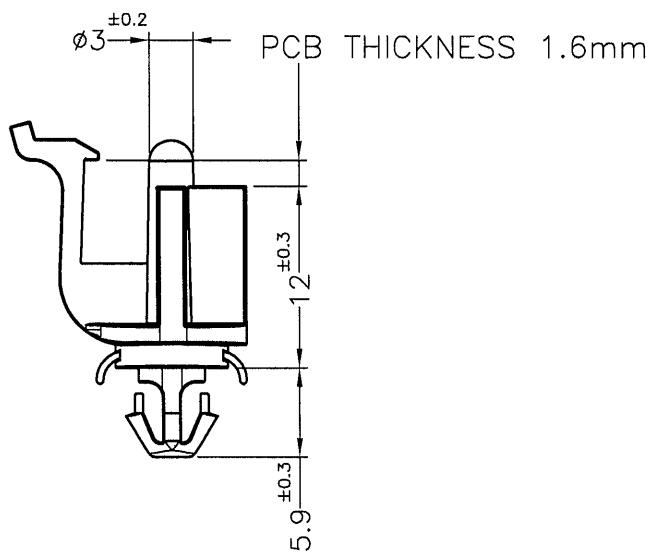
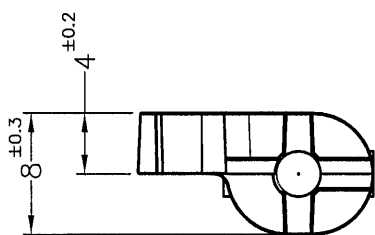

MOUNTING HOLES  
THICKNESS: 2.5~2.8mm

NOTE: MADE OF EQUIVALENT MATERIAL.  
均可使用同等材質。

 <p>康揚企業股份有限公司 KANG YANG HARDWARE ENTERPRISE CO., LTD. 康揚塑膠(東莞)有限公司 KANG YANG PLASTIC(DONG GUAN) CO., LTD. 康哲電腦配件(吳江)有限公司 KANG CHE COMPUTER COMPONENTS(WUJIANG) CO., LTD.</p>				TITLE	SPEC. DWG.
				MATERIAL	DATE
				FINISH	DRAWN
PART NUMBER	DRAWING NUMBER	COLOR	CHECK		
LCUAE-12LV0	LCUAE-12L	NATURAL(WHITE)	林祺翔		
SIZE	SCALE	UNIT	REV		
A4	2:1	mm	A		
UNLESS OTHERWISE SPECIFIED TOLERANCE			APPROVED		
SEE ABOVE			Kang		