

REVISIONS			
REV	DESCRIPTION	DATE	BY

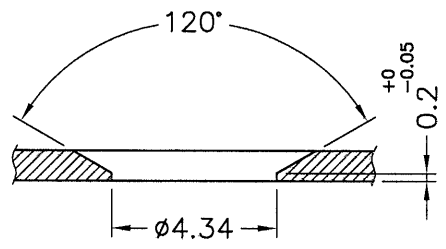

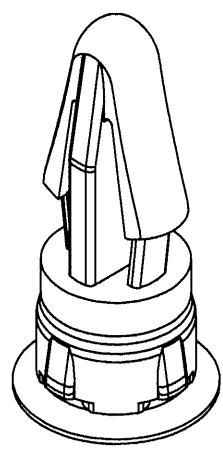

RECOMMEND MOUNTING HOLE  
RECOMMEND THICKNESS: 0.8mm

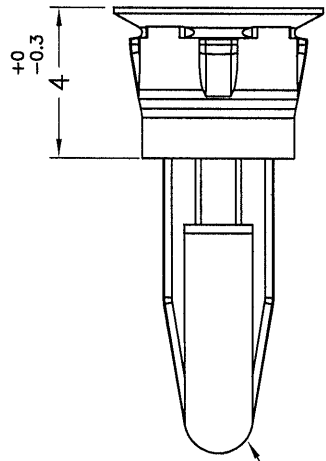
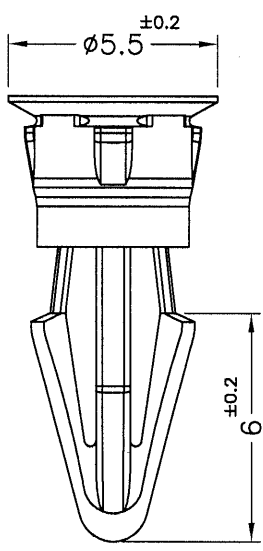

RECOMMEND MOUNTING HOLE:  $\phi 3 \sim \phi 3.18 \text{mm}$

RECOMMEND THICKNESS:  $1.6 \text{mm}$  <sup>+0</sup>/<sub>-0.05</sub>

NOTE: 1. MADE OF EQUIVALENT MATERIAL.  
均可使用同等材質。  
2. SLIGHT DEFORMED IS NORMAL STATUS.  
輕微變形為正常現象。

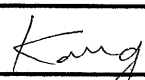
 <p>康揚企業股份有限公司 KANG YANG HARDWARE ENTERPRISE CO., LTD. 康揚塑膠(東莞)有限公司 KANG YANG PLASTIC(DONG GUAN) CO., LTD. 康哲電腦配件(吳江)有限公司 KANG CHE COMPUTER COMPONENTS(WUJIANG) CO., LTD.</p>				TITLE	SPACER SUPPORT	SPEC. DWG.	
				MATERIAL	NYLON 66 UL94V-0	DATE	2018.09.14
				FINISH		DRAWN	K.W
				COLOR	NATURAL	CHECK	
PART NUMBER	DCCB-4.1V0	DRAWING NUMBER	DCCB-4.1	UNLESS OTHERWISE SPECIFIED TOLERANCE	SEE ABOVE	APPROVED	
SIZE	A4	SCALE	5:1	UNIT	mm	REV	A