

REVISIONS			
REV	DESCRIPTION	DATE	BY

MOUNTING HOLE: $\phi 3.3\text{mm}$
THICKNESS: 1.6mm

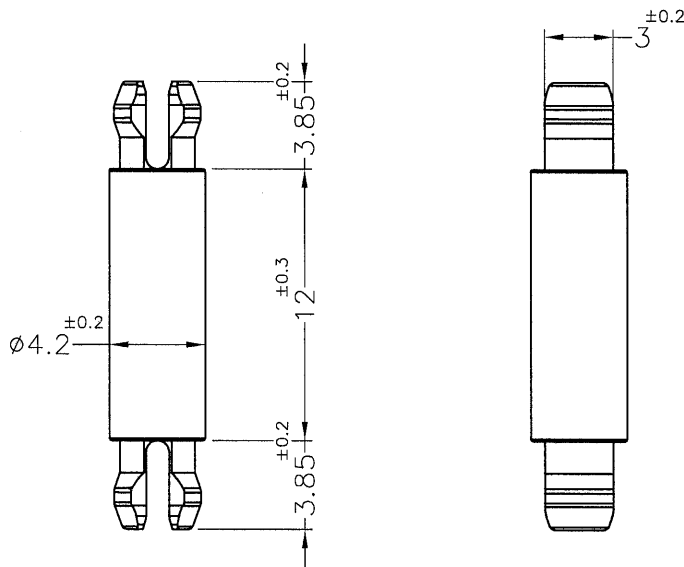

MOUNTING HOLE: $\phi 3.3\text{mm}$
THICKNESS: 1.6mm

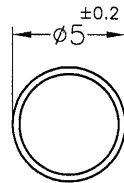
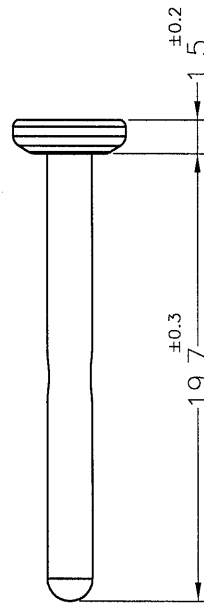





BODY

PIN

NOTE:MADE OF EQUIVALENT MATERIAL.
均可使用同等材質.

 <p>康揚企業股份有限公司 KANG YANG HARDWARE ENTERPRISE CO., LTD. 康揚塑膠(東莞)有限公司 KANG YANG PLASTIC(DONG GUAN) CO., LTD. 康哲電腦配件(吳江)有限公司 KANG CHE COMPUTER COMPONENTS(WUJIANG) CO., LTD.</p>				TITLE	SPEC. DWG.
				MATERIAL	DATE
				FINISH	DRAWN
				COLOR	CHECK
PART NUMBER	DRAWING NUMBER	UNLESS OTHERWISE SPECIFIED TOLERANCE		APPROVED	
SIZE	SCALE	UNIT	REV		

SPACER SUPPORT	2018.11.27
NYLON 66 UL94V-0	C. S. L
NATURAL(WHITE)	
SEE ABOVE	

DATE	2018.11.27
DRAWN	C. S. L
CHECK	
APPROVED	

PART NUMBER	DRAWING NUMBER	UNLESS OTHERWISE SPECIFIED TOLERANCE		APPROVED
MSPCA3.3-12SV0	MSPCA3.3-12S	SEE ABOVE		
SIZE	SCALE	UNIT	REV	
A4	3:1	mm	A	