

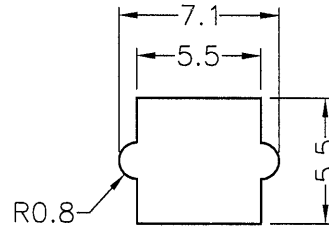

REVISIONS			
REV	DESCRIPTION	DATE	BY

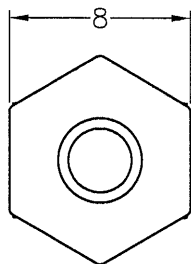

MOUNTING HOLE
CHASSIS THICKNESS:0.8~1.8

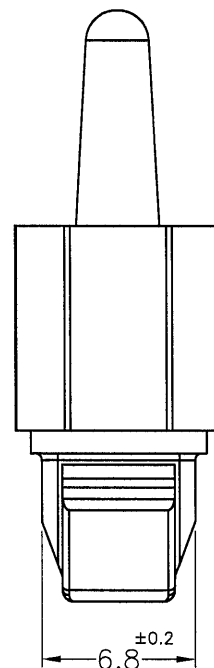
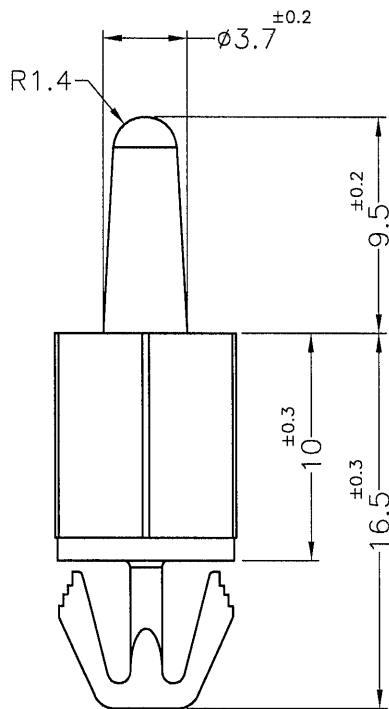

NOTE:MADE OF EQUIVALENT MATERIAL.
均可使用同等材質.

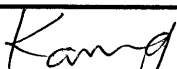
 康揚企業股份有限公司 KANG YANG HARDWARE ENTERPRISE CO., LTD. 康揚塑膠(東莞)有限公司 KANG YANG PLASTIC(DONG GUAN)CO.,LTD. 康哲電腦配件(吳江)有限公司 KANG CHE COMPUTER COMPONENTS(WUJIANG) CO.,LTD.		TITLE	SPACER SUPPORT	SPEC. DWG.
		MATERIAL	NYLON 66 UL94V-2	DATE
PART NUMBER		FINISH	DRAWN	
KVLMA-10(B)			C. S. L	
DRAWING NUMBER		COLOR	CHECK	
KVLMA-10		BLACK		
SIZE	SCALE	UNLESS OTHERWISE SPECIFIED TOLERANCE	APPROVED	
A4	3:1	SEE ABOVE		
UNIT	REV			
mm	A			