

MOUNTING HOLES

THICKNESS: T

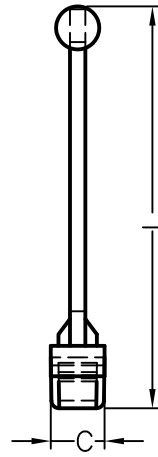
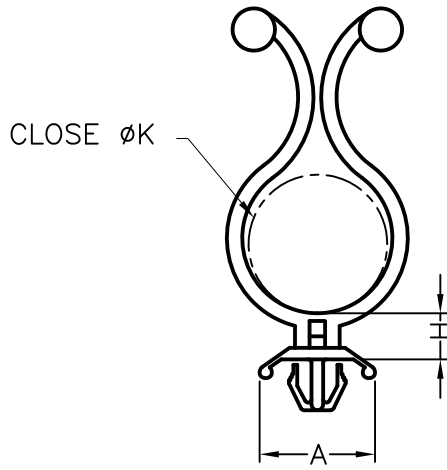

PART NO.	A	C	H	K	L	T
THG-14	15	7	6	18	52.2	1.0~2.0

NOTE: A, D